



9 1 & KDQQHO 026) (/7 & & % ;
 33\$. ; 3LQ & RQILJXUDWLRQ

% 9'66	5'621	,'
9	P:	\$

) HDWXUHV
 z 100V,45A, RDS(ON) =16.5 P @VGS = 10V
 z Improved dv/dt capability
 z Fast switching
 z 100% EAS Guaranteed
 z Green Device Available

\$SSOLFDWLRQV
 z Networking
 z Load Switch
 z LED applications

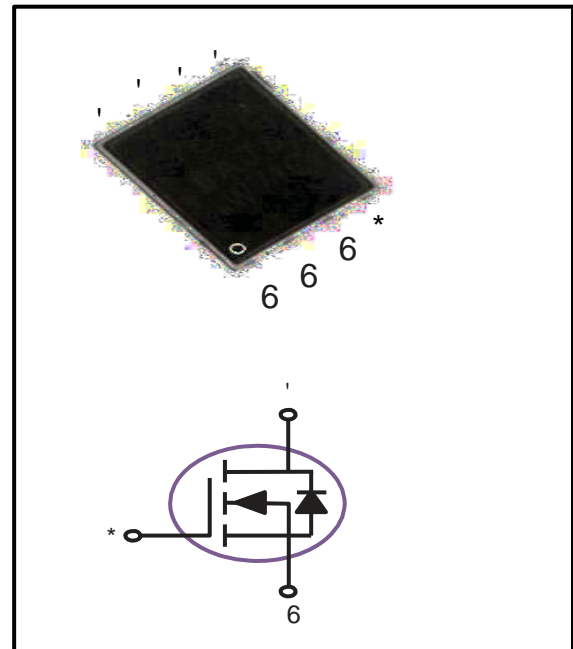

0\$; ,080 5\$7, 1*6 \$1' & +\$5\$&7(5,67, &6

f & \$PELHQW 7HPSHUDWXUH XQOHVV RWKHUZZLVH QRWHG

3DUDPHWHU	6\PERO	5DWLQJ	3QLWV
'UDLQ 6RXUFH 9ROWDJH	9 ₆		9
*DWH 6RXUFH 9ROWDJH	9 ₆	"	9
'UDLQ & XUHQW ± & RQWLQXRXV 7	,		\$
'UDLQ & XUHQW ± & RQWLQXRXV 7	,		\$
'UDLQ & XUHQW ± 3XOVHG	,0		\$
6LQJOH 3XOVH \$YDODQFKH (QHUJ\	(\$6		P-
6LQJOH 3XOVH \$YDODQFKH & XUHQW	, \$6		\$
3RZHU 'LVVLSDWLRQ 7	3		:
3RZHU 'LVVLSDWLRQ ± HUDWH DERYH	3		: u
6WRUDJH 7HPSHUDWXUH 5DQJH	7 ₆₇	WR	u
2SHUDWLQJ -XQFWLRQ 7HPSHUDWXUH 5DQJH	5DQJH	WR	u

Thermal Characteristics

3DUDPHWHU	6\PERO	7\S	0D[8QLWV
7KHUPDO 5HVLVWDQFH -XQFWLRQ WR DPDLHQW				u :
7KHUPDO 5HVLVWDQFH -XQFWLRQ WR & DVH 5-&				u :

9 1 &KDQQHO 026)(76 /'&

026)(7 (/(&75, &\$ / & + \$5\$ &7(5, 0_s7, &6

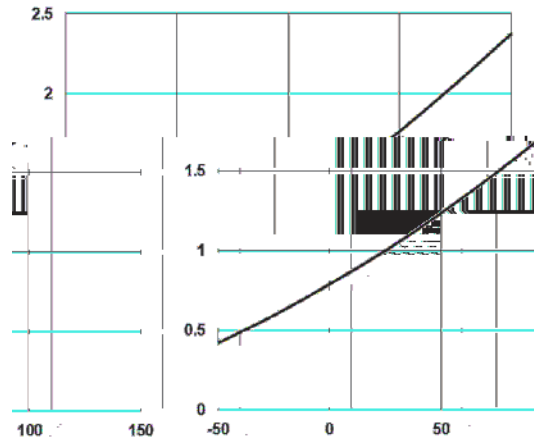



9 1 & KDQQHO 026) (7 & & % ;

1RUPDOLJHG 7KHUPD

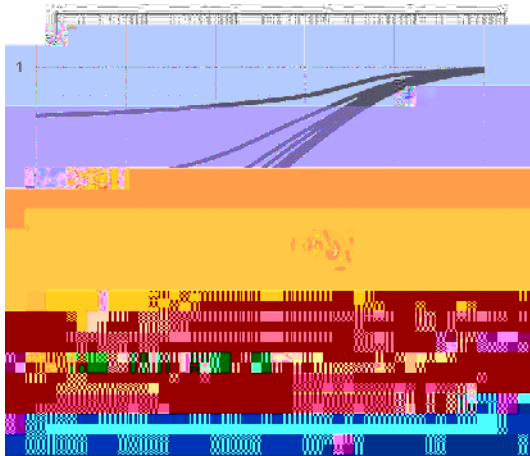

& RQWLQXR XV 'UDLQ

6TXDUH :DYH 3XOVH 'XUDWLRQ V 9₆ 'UDLQ WR 6RXUFH 9ROWDJH
)LJ 1RUPDOLJHG 7UDQVLHQW ,PS)GDQFD[LPXP 6DIH 2SHUDWLRQ \$UHD

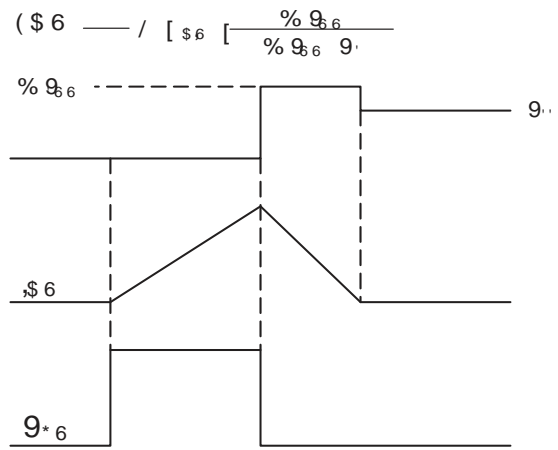
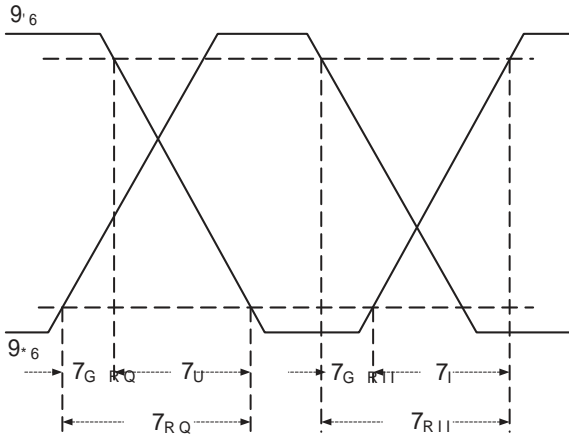

)LJ 6ZLWFKLQJ 7LPH :DYHIRUP)LJ (\$6 :DYHIRUP

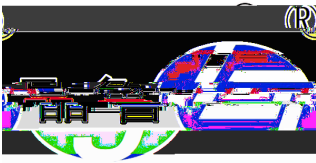

9 1 & KDQQHO 026) (7 & & %;

33\$. [3\$&.\$*(, 1)250\$7,21

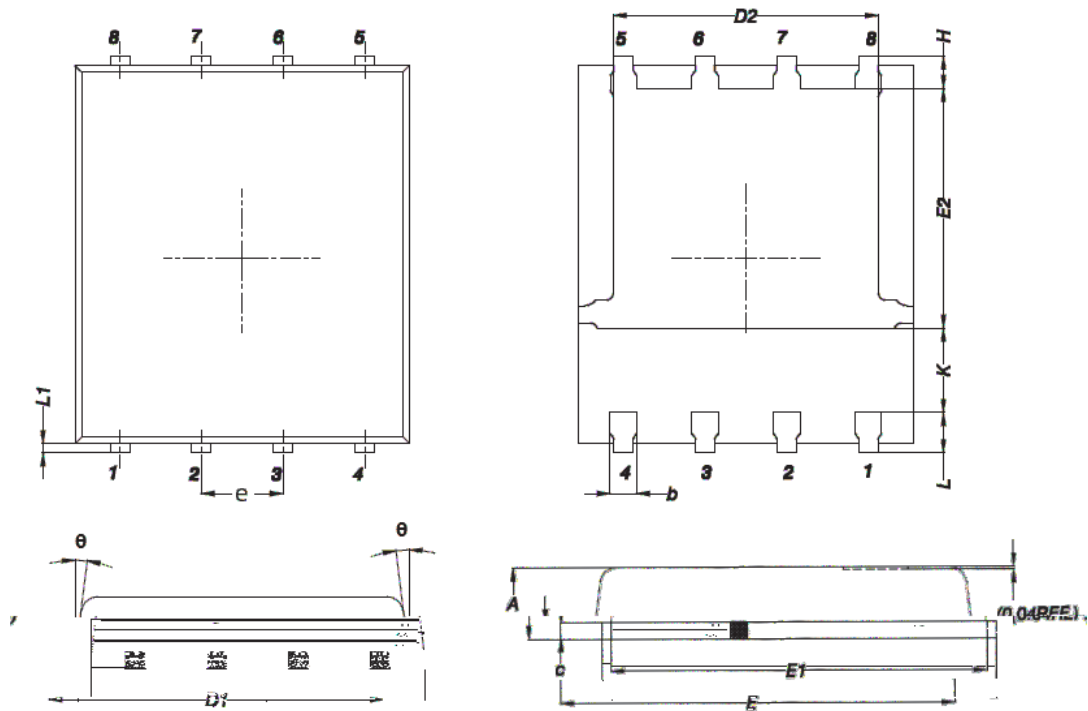

6 \ PERO	'LPHQVLRQV , Q 0LO		OLPHWHUHQVLRQV , Q , QFKHV	
	0\$;	0,1	0\$;	0,1
\$				
E				
&				
'				
'				
(
(
(
H	% 6 &		% 6 &	
+				
.				
/				
/				
	<i>f</i>	<i>f</i>	<i>f</i>	<i>f</i>